

# STAMFORD<sup>®</sup>

**HCI 434D/444D - Winding 311**

Technical Data Sheet

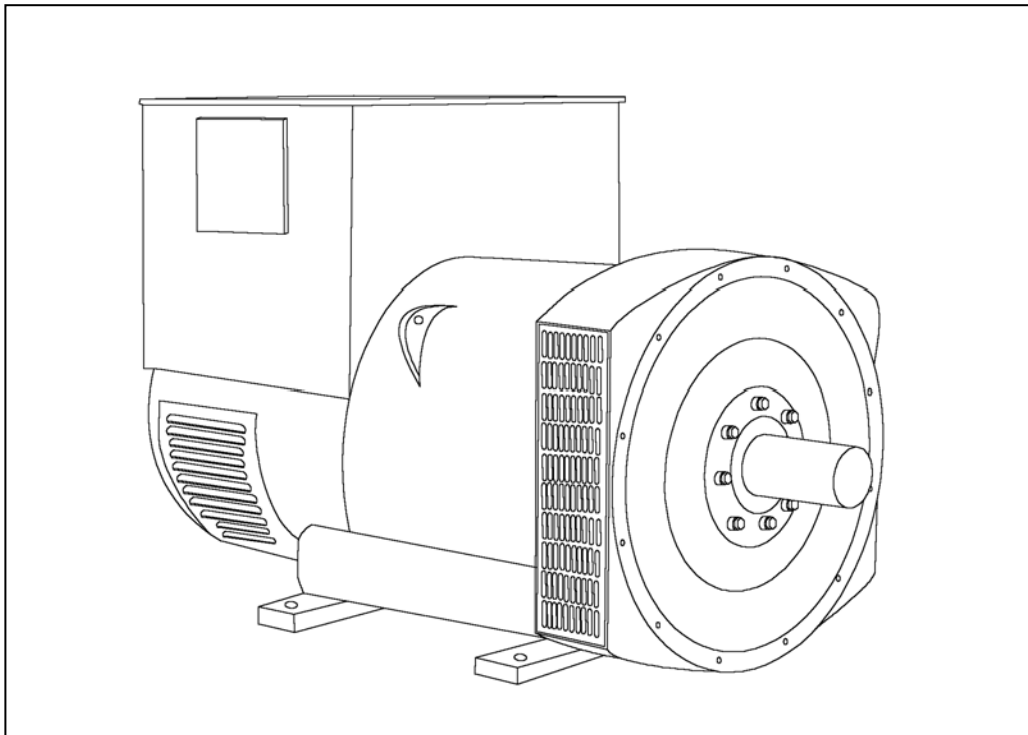

# HCI434D/444D

## SPECIFICATIONS & OPTIONS

**STAMFORD**

### STANDARDS

Stamford industrial generators meet the requirements of BS EN60034 and the relevant section of other international standards such as BS5000, VDE 0530, NEMA MG1-32, IEC34, CSA C22.2 100, AS1359.

Other standards and certifications can be considered on request.

### VOLTAGE REGULATORS

#### AS440 AVR - STANDARD

With this self-excited system the main stator provides power via the Automatic Voltage Regulator (AVR) to the exciter stator. The high efficiency semi-conductors of the AVR ensure positive build-up from initial low levels of residual voltage.

The exciter rotor output is fed to the main rotor through a three-phase full-wave bridge rectifier. The rectifier is protected by a surge suppressor against surges caused, for example, by short circuit or out-of-phase paralleling.

The AS440 will support a range of electronic accessories, including a 'droop' Current Transformer (CT) to permit parallel operation with other ac generators.

#### MX341 AVR

This sophisticated AVR is incorporated into the Stamford Permanent Magnet Generator (PMG) control system.

The PMG provides power via the AVR to the main exciter, giving a source of constant excitation power independent of generator output. The main exciter output is then fed to the main rotor through a full wave bridge, protected by a surge suppressor. The AVR has in-built protection against sustained over excitation, caused by internal or external faults. This de-excites the machine after a minimum of 5 seconds.

An engine relief load acceptance feature can enable full load to be applied to the generator in a single step.

If three-phase sensing is required with the PMG system the MX321 AVR must be used.

We recommend three-phase sensing for applications with greatly unbalanced or highly non-linear loads.

#### MX321 AVR

The most sophisticated of all our AVRs combines all the features of the MX341 with, additionally, three-phase rms sensing, for improved regulation and performance.

Over voltage protection is built-in and short circuit current level adjustments is an optional facility.

### WINDINGS & ELECTRICAL PERFORMANCE

All generator stators are wound to 2/3 pitch. This eliminates triplen (3rd, 9th, 15th ...) harmonics on the voltage waveform and is found to be the optimum design for trouble-free supply of non-linear loads. The 2/3 pitch design avoids excessive neutral currents sometimes seen with higher winding pitches, when in parallel with the mains. A fully connected damper winding reduces oscillations during paralleling. This winding, with the 2/3 pitch and carefully selected pole and tooth designs, ensures very low waveform distortion.

### TERMINALS & TERMINAL BOX

Standard generators are 3-phase reconnectable with 12 ends brought out to the terminals, which are mounted on a cover at the non-drive end of the generator. A sheet steel terminal box contains the AVR and provides ample space for the customers' wiring and gland arrangements. It has removable panels for easy access.

### SHAFT & KEYS

All generator rotors are dynamically balanced to better than BS6861:Part 1 Grade 2.5 for minimum vibration in operation. Two bearing generators are balanced with a half key.

### INSULATION/IMPREGNATION

The insulation system is class 'H'.

All wound components are impregnated with materials and processes designed specifically to provide the high build required for static windings and the high mechanical strength required for rotating components.

### QUALITY ASSURANCE

Generators are manufactured using production procedures having a quality assurance level to BS EN ISO 9001.

The stated voltage regulation may not be maintained in the presence of certain radio transmitted signals. Any change in performance will fall within the limits of Criteria 'B' of EN61000-6-2:2001. At no time will the steady-state voltage regulation exceed 2%.

### DE RATES

All values tabulated on page 8 are subject to the following reductions

5% when air inlet filters are fitted.

3% for every 500 metres by which the operating altitude exceeds 1000 metres above mean sea level.

3% for every 5°C by which the operational ambient temperature exceeds 40°C.

Note: Requirement for operating in an ambient exceeding 60°C must be referred to the factory.

*NB Continuous development of our products entitles us to change specification details without notice, therefore they must not be regarded as binding.*

*Front cover drawing typical of product range.*

APPROVED DOCUMENT

# HCI434D/444D

**STAMFORD**

## WINDING 311

CONTROL SYSTEM	SEPARATELY EXCITED BY P.M.G.							
A.V.R.	MX321	MX341						
VOLTAGE REGULATION	± 0.5 %	± 1.0 %	With 4% ENGINE GOVERNING					
SUSTAINED SHORT CIRCUIT	REFER TO SHORT CIRCUIT DECREMENT CURVES (page 7)							
CONTROL SYSTEM	SELF EXCITED							
A.V.R.	AS440							
VOLTAGE REGULATION	± 1.0 %	With 4% ENGINE GOVERNING						
SUSTAINED SHORT CIRCUIT	WILL NOT SUSTAIN A SHORT CIRCUIT							
INSULATION SYSTEM	CLASS H							
PROTECTION	IP23							
RATED POWER FACTOR	0.8							
STATOR WINDING	DOUBLE LAYER LAP							
WINDING PITCH	TWO THIRDS							
WINDING LEADS	12							
STATOR WDG. RESISTANCE	0.0124 Ohms PER PHASE AT 22°C SERIES STAR CONNECTED							
ROTOR WDG. RESISTANCE	1.05 Ohms at 22°C							
EXCITER STATOR RESISTANCE	18 Ohms at 22°C							
EXCITER ROTOR RESISTANCE	0.068 Ohms PER PHASE AT 22°C							
R.F.I. SUPPRESSION	BS EN61000-6-2 & BS EN61000-6-4, VDE 0875G, VDE 0875N. refer to factory for others							
WAVEFORM DISTORTION	NO LOAD < 1.5% NON-DISTORTING BALANCED LINEAR LOAD < 5.0%							
MAXIMUM OVERSPEED	2250 Rev/Min							
BEARING DRIVE END	BALL. 6317 (ISO)							
BEARING NON-DRIVE END	BALL. 6314 (ISO)							
	1 BEARING				2 BEARING			
WEIGHT COMP. GENERATOR	940 kg				950 kg			
WEIGHT WOUND STATOR	415 kg				415 kg			
WEIGHT WOUND ROTOR	361 kg				338 kg			
WR <sup>2</sup> INERTIA	4.0771 kgm <sup>2</sup>				3.8783 kgm <sup>2</sup>			
SHIPPING WEIGHTS in a crate	1010 kg				1010 kg			
PACKING CRATE SIZE	155 x 87 x 107 (cm)				155 x 87 x 107 (cm)			
	50 Hz				60 Hz			
TELEPHONE INTERFERENCE	THF < 2%				TIF < 50			
COOLING AIR	0.8 m <sup>3</sup> /sec 1700 cfm				0.99 m <sup>3</sup> /sec 2100 cfm			
VOLTAGE SERIES STAR	380/220	400/231	415/240	440/254	416/240	440/254	460/266	480/277
VOLTAGE PARALLEL STAR	190/110	200/115	208/120	220/127	208/120	220/127	230/133	240/138
VOLTAGE SERIES DELTA	220/110	230/115	240/120	254/127	240/120	254/127	266/133	277/138
KVA BASE RATING FOR REACTANCE VALUES	300	300	300	290	344	360	375	375
X <sub>d</sub> DIR. AXIS SYNCHRONOUS	3.16	2.85	2.65	2.28	3.60	3.37	3.21	2.95
X' <sub>d</sub> DIR. AXIS TRANSIENT	0.20	0.18	0.17	0.15	0.22	0.21	0.20	0.18
X'' <sub>d</sub> DIR. AXIS SUBTRANSIENT	0.14	0.13	0.12	0.10	0.15	0.14	0.14	0.12
X <sub>q</sub> QUAD. AXIS REACTANCE	2.66	2.40	2.23	1.92	3.09	2.89	2.75	2.53
X'' <sub>q</sub> QUAD. AXIS SUBTRANSIENT	0.39	0.36	0.33	0.28	0.40	0.38	0.36	0.33
X <sub>L</sub> LEAKAGE REACTANCE	0.07	0.06	0.06	0.05	0.09	0.09	0.08	0.07
X <sub>2</sub> NEGATIVE SEQUENCE	0.26	0.24	0.22	0.19	0.28	0.27	0.25	0.23
X <sub>0</sub> ZERO SEQUENCE	0.10	0.09	0.08	0.07	0.10	0.09	0.09	0.08
REACTANCES ARE SATURATED VALUES ARE PER UNIT AT RATING AND VOLTAGE INDICATED								
T' <sub>d</sub> TRANSIENT TIME CONST.	0.08s							
T'' <sub>d</sub> SUB-TRANSTIME CONST.	0.019s							
T' <sub>do</sub> O.C. FIELD TIME CONST.	1.7s							
T <sub>a</sub> ARMATURE TIME CONST.	0.018s							
SHORT CIRCUIT RATIO	1/X <sub>d</sub>							

**50  
Hz**

**HCI434D/444D**

**STAMFORD**

**Winding 311**

**THREE PHASE EFFICIENCY CURVES**

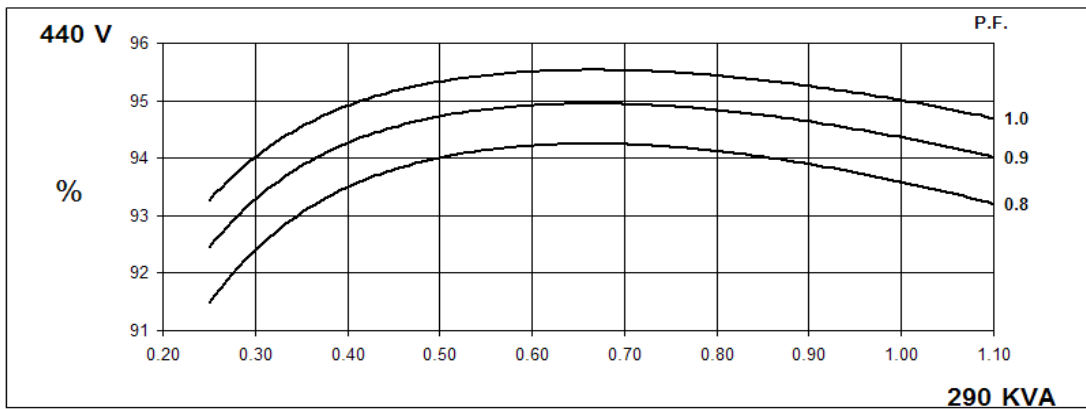
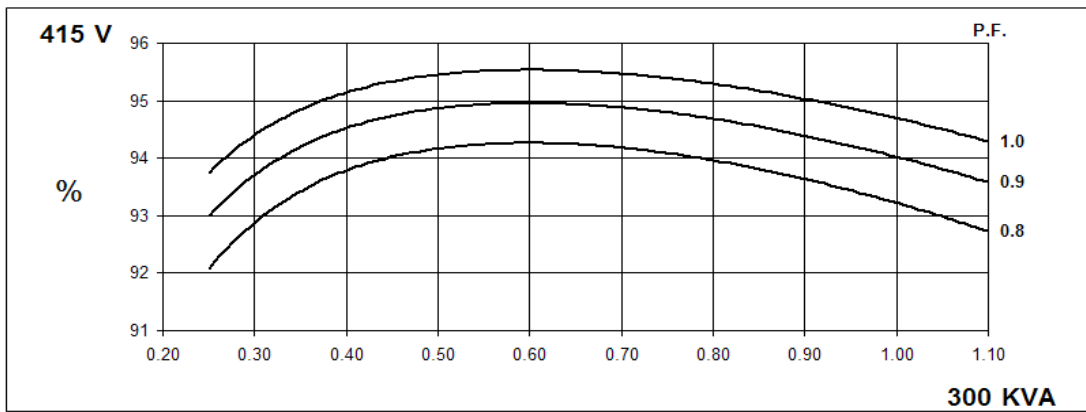
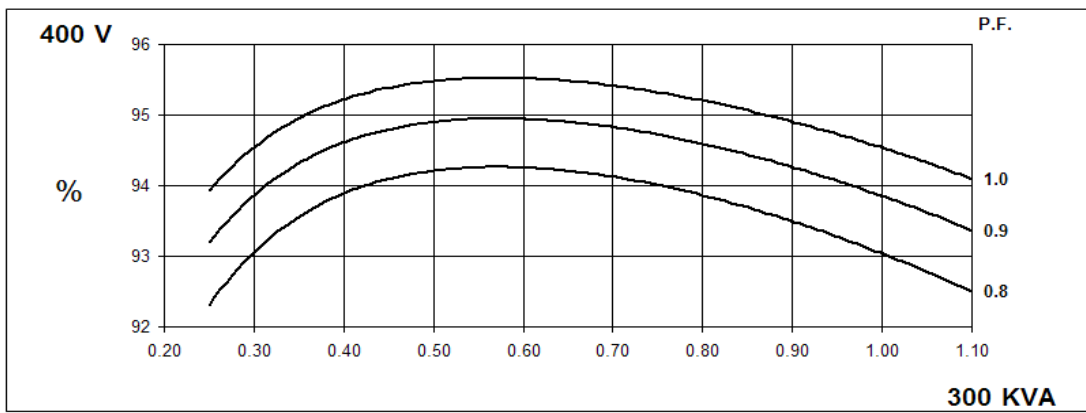
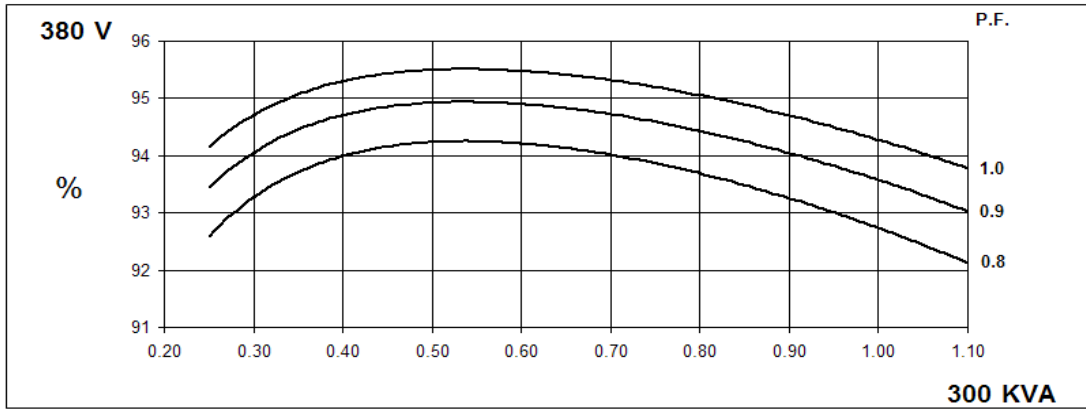

**60  
Hz**

**HCI434D/444D**

**STAMFORD**

**Winding 311**

**THREE PHASE EFFICIENCY CURVES**

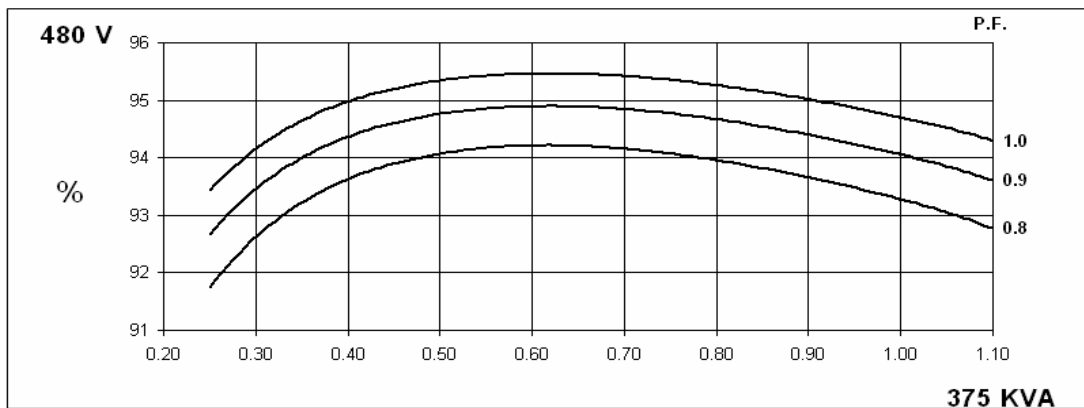
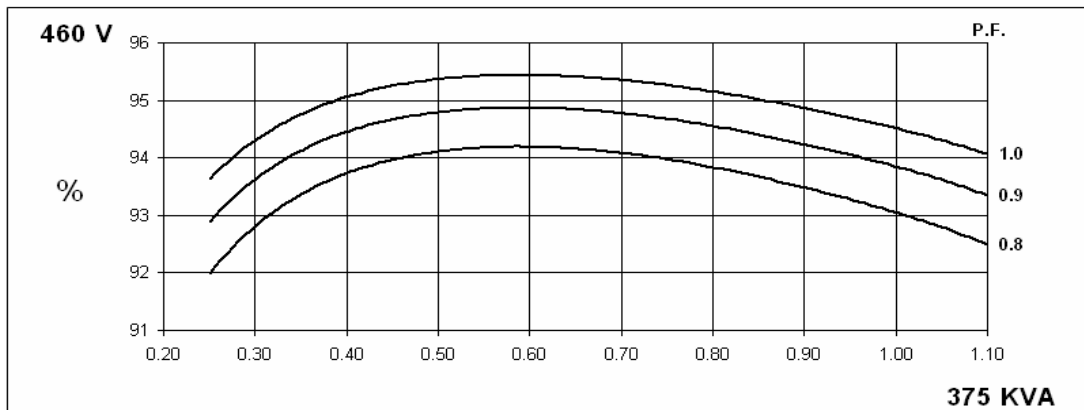
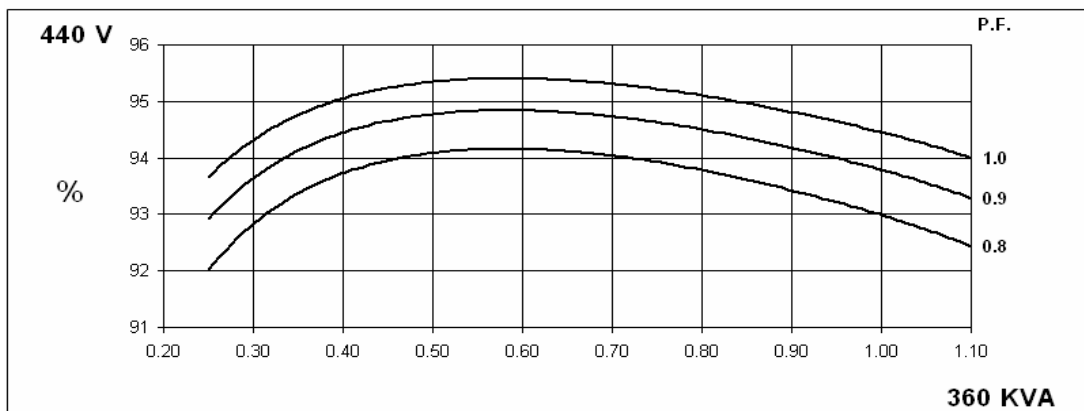
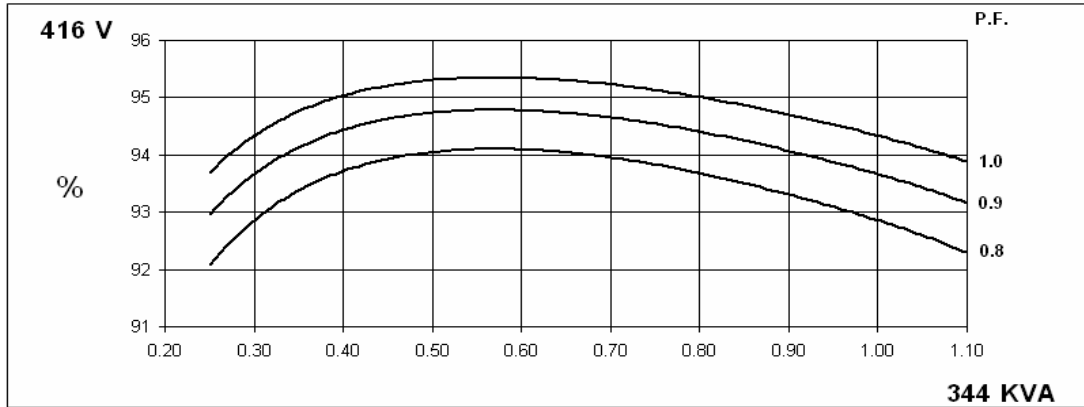

Locked Rotor Motor Starting Curve

50 Hz

MX

SX

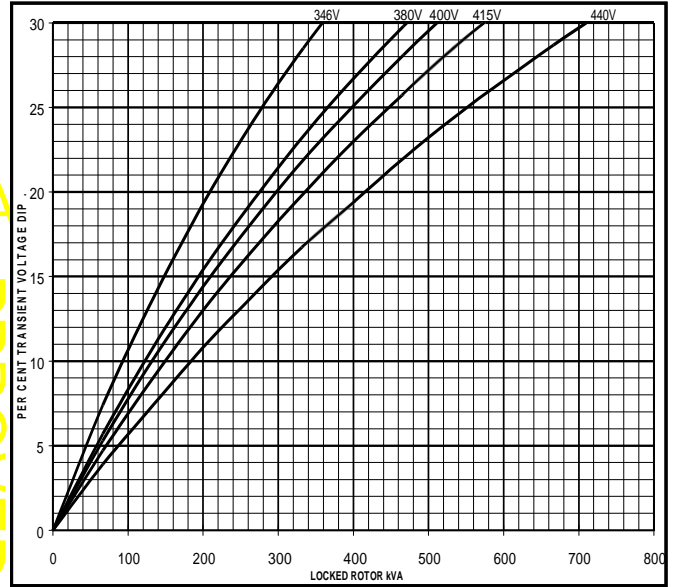
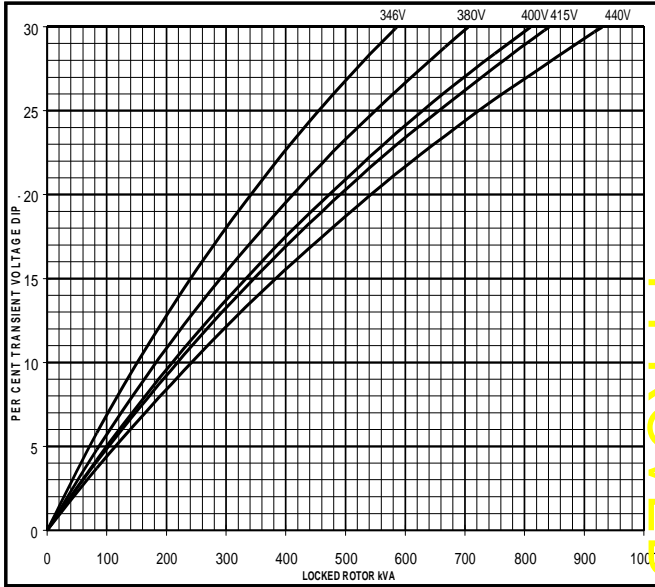

APPROVED DOCUMENT

60 Hz

MX

SX

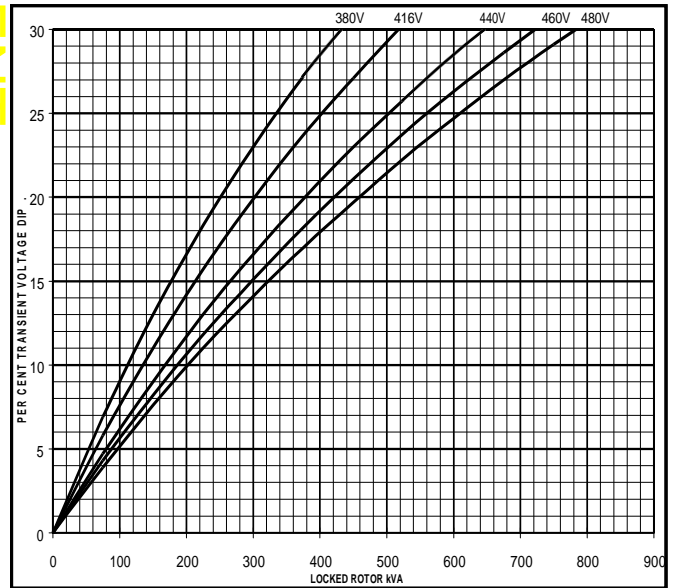
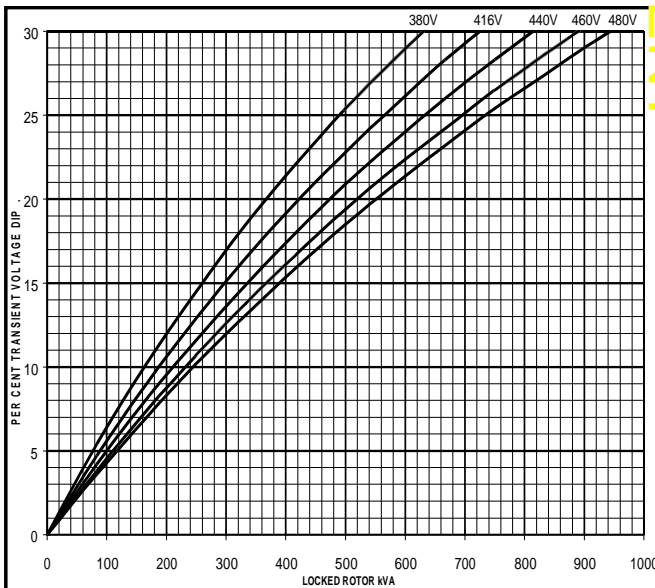

Three-phase Short Circuit Decrement Curve. No-load Excitation at Rated Speed  
Based on star (wye) connection.

**50  
Hz**

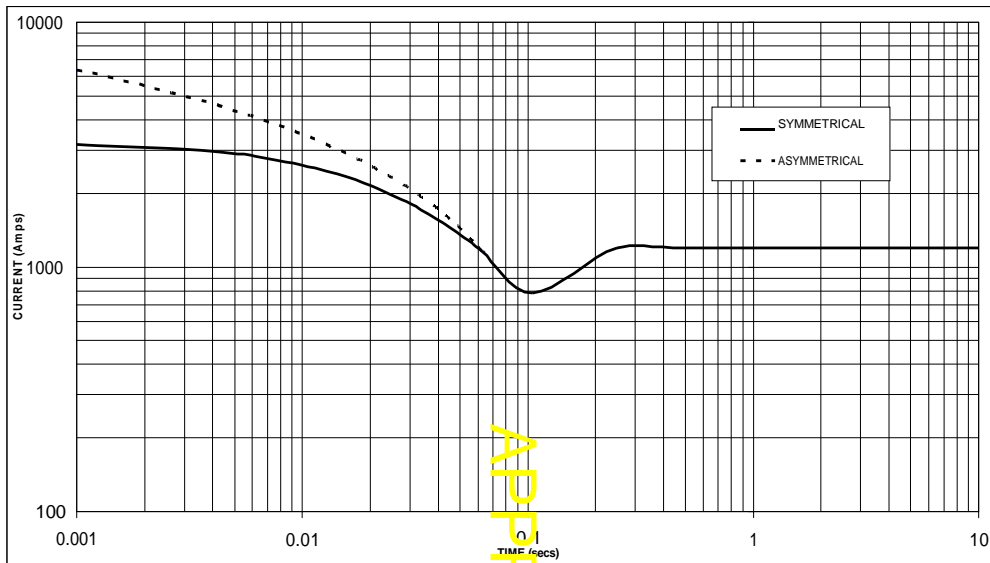

Sustained Short Circuit = 1,200 Amps

**60  
Hz**

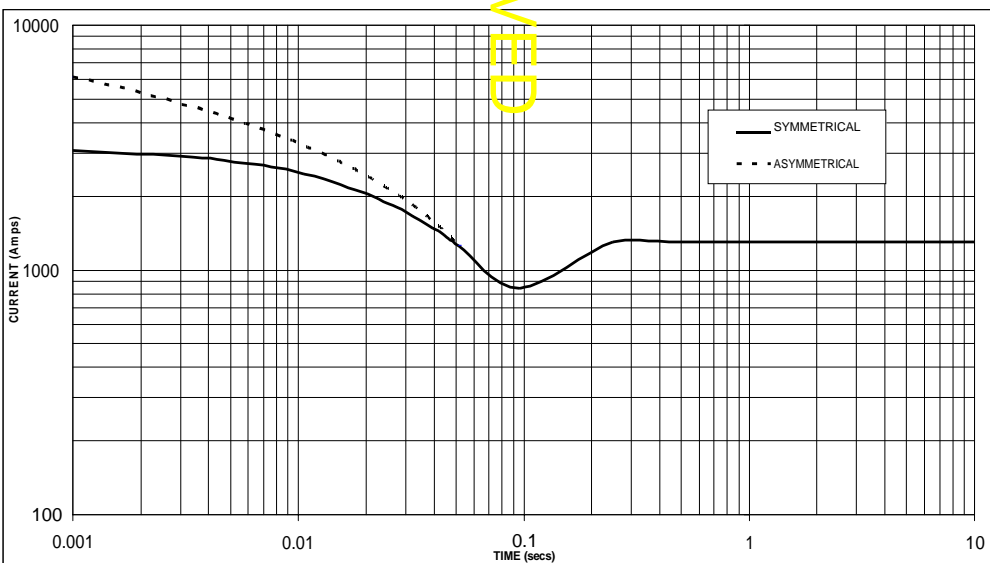

Sustained Short Circuit = 1,300 Amps

APPROVED

**Note 1**

The following multiplication factors should be used to adjust the values from curve between time 0.001 seconds and the minimum current point in respect of nominal operating voltage :

50Hz		60Hz	
Voltage	Factor	Voltage	Factor
380v	X 1.00	416v	X 1.00
400v	X 1.05	440v	X 1.06
415v	X 1.09	460v	X 1.10
440v	X 1.16	480v	X 1.15

The sustained current value is constant irrespective of voltage level

**Note 2**

The following multiplication factor should be used to convert the values calculated in accordance with NOTE 1 to those applicable to the various types of short circuit :

	3-phase	2-phase L-L	1-phase L-N
Instantaneous	x 1.00	x 0.87	x 1.30
Minimum	x 1.00	x 1.80	x 3.20
Sustained	x 1.00	x 1.50	x 2.50
Max. sustained duration	10 sec.	5 sec.	2 sec.

All other times are unchanged

**Note 3**

Curves are drawn for Star (Wye) connected machines. For other connection the following multipliers should be applied to current values as shown :

# HCI434D/444D

**STAMFORD**

## Winding 311 / 0.8 Power Factor

### RATINGS

Class - Temp Rise	Cont. F - 105/40°C				Cont. H - 125/40°C				Standby - 150/40°C				Standby - 163/27°C				
<b>50 Hz</b>	Series Star (V)	380	400	415	440	380	400	415	440	380	400	415	440	380	400	415	440
	Parallel Star (V)	190	200	208	220	190	200	208	220	190	200	208	220	190	200	208	220
	Series Delta (V)	220	230	240	254	220	230	240	254	220	230	240	254	220	230	240	254
kVA	280	280	280	270	300	300	300	290	320	320	320	310	330	330	330	320	
kW	224	224	224	216	240	240	240	232	256	256	256	248	264	264	264	256	
Efficiency (%)	93.1	93.4	93.5	93.8	92.7	93.0	93.2	93.6	92.3	92.7	92.9	93.3	92.1	92.5	92.7	93.2	
kW Input	241	240	240	230	259	258	258	248	277	276	276	266	287	285	285	275	

<b>60 Hz</b>	Series Star (V)	416	440	460	480	416	440	460	480	416	440	460	480	416	440	460	480
	Parallel Star (V)	208	220	230	240	208	220	230	240	208	220	230	240	208	220	230	240
	Series Delta (V)	240	254	266	277	240	254	266	277	240	254	266	277	240	254	266	277
kVA	315	335	345	345	344	360	375	375	365	385	400	400	375	395	415	415	
kW	252	268	276	276	275	288	300	300	292	308	320	320	300	316	332	332	
Efficiency (%)	93.3	93.3	93.4	93.6	92.9	93.0	93.1	93.3	92.5	92.6	92.7	93.0	92.4	92.5	92.5	92.8	
kW Input	270	287	296	295	296	310	322	322	316	333	345	344	325	342	359	358	

### DIMENSIONS

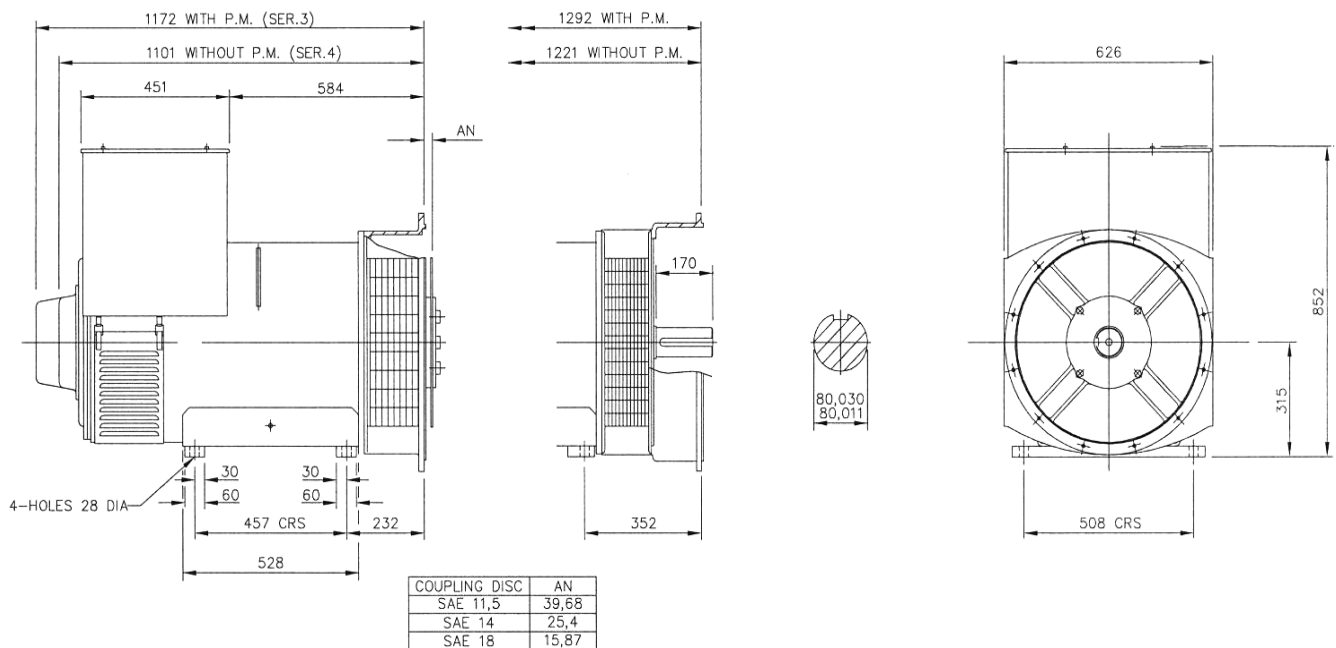



APPROVED DOCUMENT

**STAMFORD**

Head Office Address:  
Barnack Road, Stamford  
Lincolnshire, PE9 2NB  
United Kingdom  
Tel: +44 (0) 1780 484000  
Fax: +44 (0) 1780 484100

[www.cumminsgeneratortechnologies.com](http://www.cumminsgeneratortechnologies.com)

Copyright 2010, Cummins Generator Technologies Ltd, All Rights Reserved  
Stamford and AvK are registered trade marks of Cummins Generator Technologies Ltd  
Cummins and the Cummins logo are registered trade marks of Cummins Inc.